

Swinghandle mechatronic with LED, RS 105 for PHZ, RC2

MLE1102 LED



Advantages

- Electronic unlocking by applying voltage.
- Opening readiness is visualized by LED.
- Handle status can be evaluated.
- Tested according to security class RC2 DIN EN 1630. Only in combination with profile half cylinders according to DIN 18252.
- Mechanical emergency opening by key cylinder 30/10mm or 35/10mm.
- Vibration-proof according to DIN EN 61373.
- IP65 according to DIN EN 60529.
- Cylinder cover magnetically secured.
- RH / LH application.

Material

Handle, dish, cover and cap: zinc die, RAL 7038 or RAL 9005

Remarks

(S) Door-thickness max. 3mm

1. stroke 18mm
2. clearance

Further technical details please see data sheet

Profile half cylinders and their assembly must be ordered separately.

Attention:

Please note that these products are not available in North America. But please contact DIRAK Inc. to discuss alternatives.

Swinghandle MLE1102 LED

	Product number	Surface	Voltage	LED	Installation type	Delivery Unit
a)	602-9003.00-GR012	grey RAL 7038	12V	green	screw-on	1 pc.
a)	602-9003.00-GR024	grey RAL 7038	24V	green	screw-on	1 pc.
a)	602-9003.00-GR048	grey RAL 7038	48V	green	screw-on	1 pc.

	Product number	Surface	Voltage	LED	Installation type	Delivery Unit
a1)	602-9004.00-GR012	black RAL 9005	12V	green	screw-on	1 pc.
a1)	602-9004.00-GR024	black RAL 9005	24V	green	screw-on	1 pc.
a1)	602-9004.00-GR048	black RAL 9005	48V	green	screw-on	1 pc.

Opening Instructions

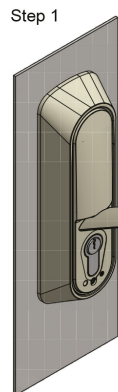

Öffnen der Abdeckung.
Open the cover.

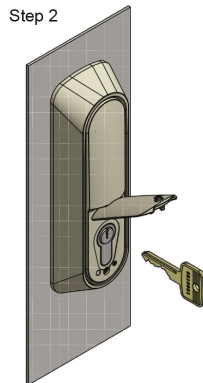

Schlüssel in den Profilzylinder stecken.
Insert key in the Profil Cylinder.

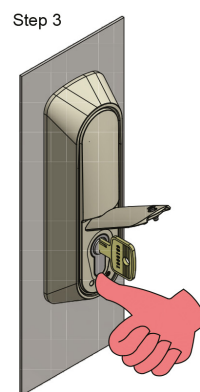

Schwenkgriff an dieser Position in richtung Muldenseite drücken.
Press down the swinghandle on this position into the dish side.

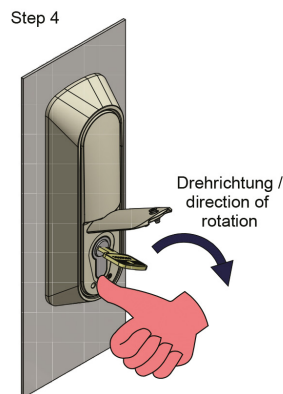

Schwenkgriff gedrückt halten und den Schlüssel nach rechts (Uhrzeigersinn) drehen.
Hold swinghandle and turn the key to right (clockwise)

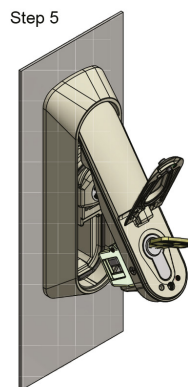

Dann den Schwenkgriff anheben.
Then lift up the swinghandle.



Attention: Risk of crushing and abrasion when pressing shut the swinghandle. Be careful not to injure yourself when closing the handle.

Liability clause for sales products

The above information and our technical application advice, whether verbal, in writing or by means of tests, are given to the best of our knowledge. However, this information shall be regarded as non-binding only, also with regard to any third-party property rights.

This information does not exempt you from conducting your own review of our current advisory suggestions. This applies in particular to the technical information on our products in terms of their suitability for use and application.

The application, use and processing of our products and the products manufactured by you on the basis of our technical application advice are beyond our control and are therefore exclusively your responsibility.

The sale of our products is subject to our current general terms and conditions of sale and delivery.

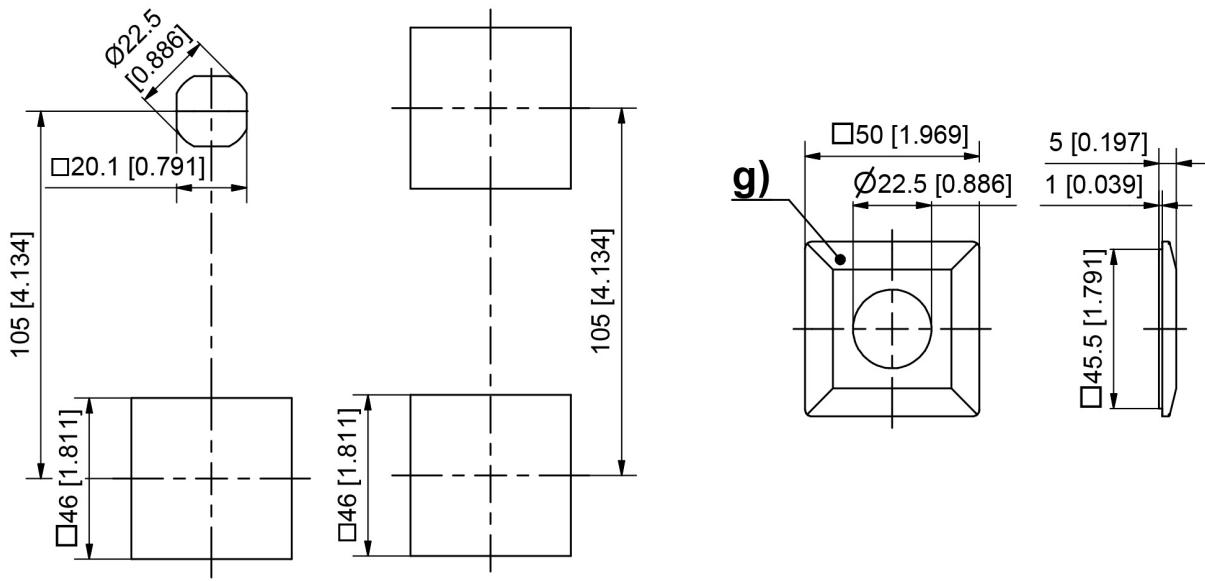

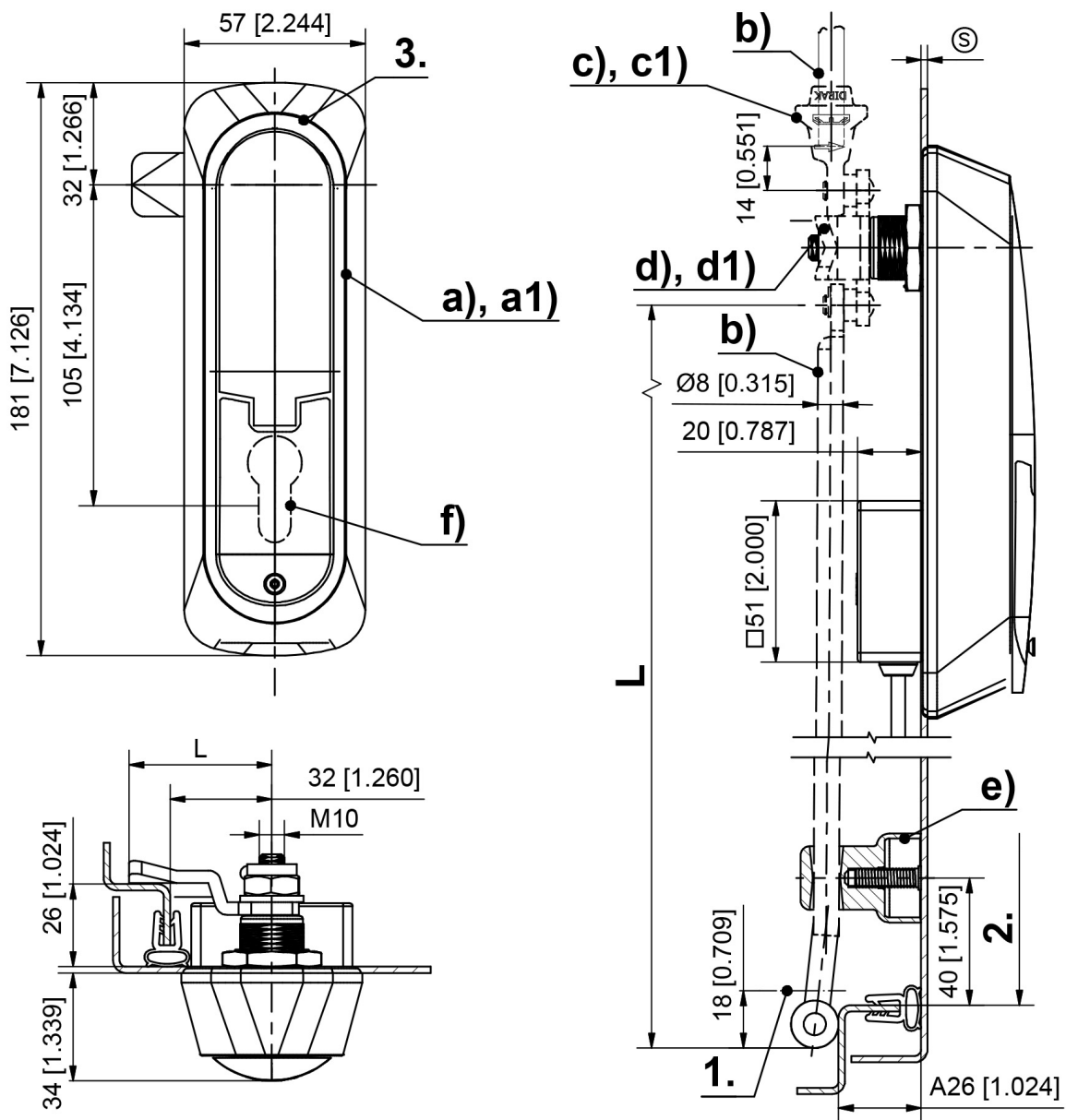

Functionality/Activation

Mechanical opening option via profile cylinder or electronic opening/release by applying voltage.
Handle status (open/closed) can be evaluated.

Open/Close status

Handle status can be evaluated via integrated potential-free reed sensor

- Contact form: Normally open contact (when the handle is closed, the contact is closed)
- Switching voltage: max. 30V DC
- Transport current, switching current: max. 0.5A
- Sensor resistance: 280 mohm
- Working temperature: Cable will not be moved -30°C to 80°C; cable will be moved -5°C to 80°C

Technical data

- Power supply (DC): 12V/24V/48V
- Current: 250mA/140mA/80mA
- Temperature range: -20°C to 70°C
- Features: IP65 according to DIN EN 60529:2014 (tightening torque 3-4 Nm); RC2 according to DIN EN 1630:2011-09; vibration-proof according to DIN EN 61373:2011; mechanical emergency opening via profile cylinder with length 30/10mm and 35/10mm according to DIN EN 18252
- Solenoid: Duty cycle = 100%
- Wall/sheet thickness: up to 3mm
- Opening cycles: > 50,000
- ROHS, REACH

Wire designation

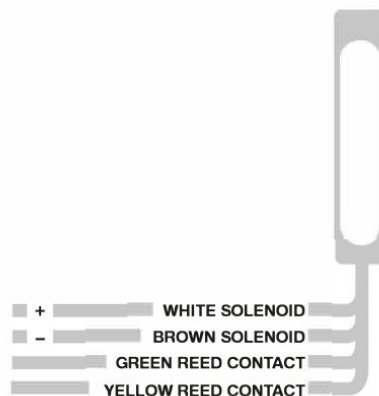

Connection line

- Length: 4m
- Ø 4.4mm with 4 single wires cross-section 0.25mm²